



CEILING

# Frame

The Frame is a family of 3D acoustic wall panels with a classic retro cornice design. The Frame family includes 2 different DESIGNS. the panels come in a variety of shades from our updated color palette and can be painted in any desired shade



THICKNESS  
9 mm

SIZE  
600x600 mm / 595x595 mm  
1200x600 mm / 1195x595 mm



Specifications	3
Models	4
Isometry	5
Color Palette	6
Wood Collection	8
Installation - Method 1	10
Installation - Method 2	12



Manufactured From	Panels						
Composition	100% Polyester (PET)						
Sustainability	70% Recycled drinking bottles						
Application	suspending ceiling / direct fixed						
Fire Rating	EN13501-1 B S-1 d0						
Size	600×600 mm / 595×595 mm 1200×600 mm / 1195×595 mm						
Thickness	9 mm (tolerance ±7%)						
Installation	Varies						
Acoustic	<table border="0" style="border-collapse: collapse;"> <tr> <td style="padding-right: 10px;">0 mm gap</td> <td style="border-left: 1px solid black; padding-left: 10px;"><math>\alpha_w = 0.25</math></td> </tr> <tr> <td>50 mm gap</td> <td style="border-left: 1px solid black; padding-left: 10px;"><math>\alpha_w = 0.55</math> (beteen product and back plain)</td> </tr> <tr> <td>200 mm gap</td> <td style="border-left: 1px solid black; padding-left: 10px;"><math>\alpha_w = 0.85</math> (beteen product and back plain)</td> </tr> </table>	0 mm gap	$\alpha_w = 0.25$	50 mm gap	$\alpha_w = 0.55$ (beteen product and back plain)	200 mm gap	$\alpha_w = 0.85$ (beteen product and back plain)
0 mm gap	$\alpha_w = 0.25$						
50 mm gap	$\alpha_w = 0.55$ (beteen product and back plain)						
200 mm gap	$\alpha_w = 0.85$ (beteen product and back plain)						
VOC	According to EN ISO 16000-9 Standard: A+						
Pattern Repeat	Non-woven with a consistent pattern repeat. Despite slight variations due to fiber blending and lay-up, inherent to the product, it maintains uniformity in design, offering a unique yet coherent aesthetic.						
Color Fading	Assessment of color fastness according to EN 1587 Assessed against the grey scale ISO-A02.						
Care	Can be simply clean using a damp cloth and vacuum cleaner.						

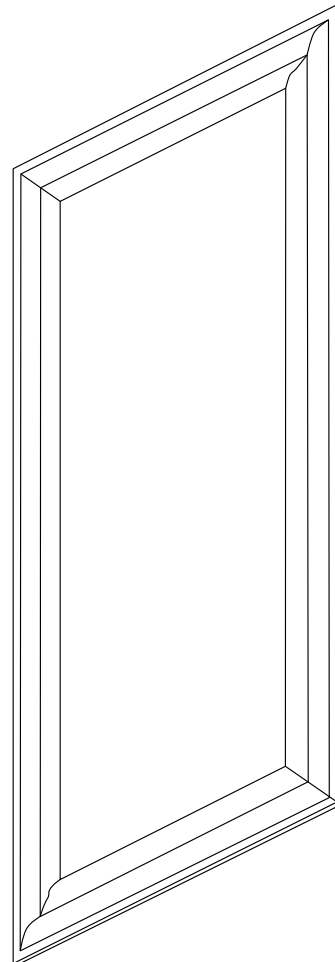
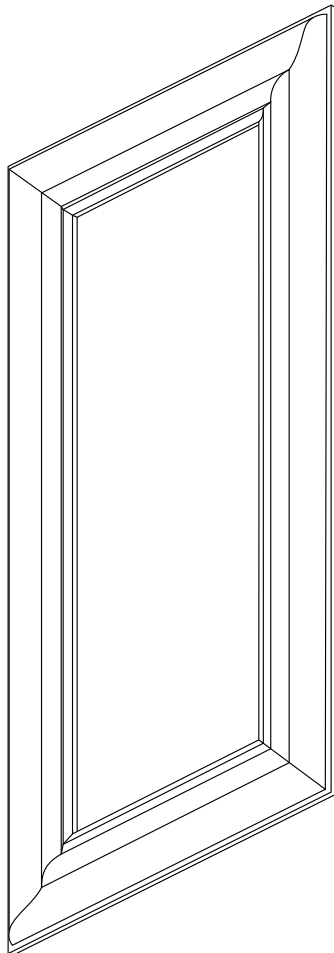
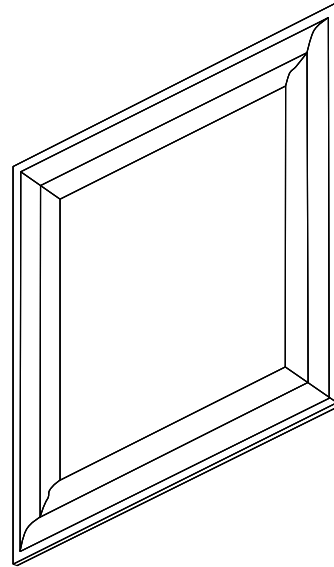
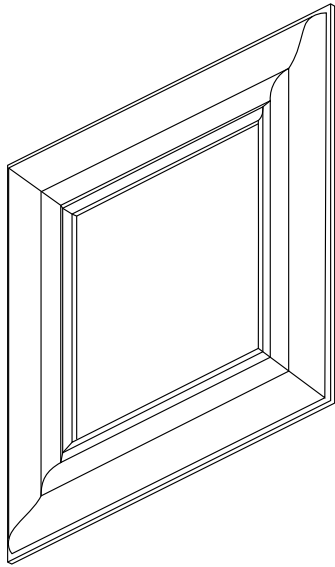

**Frame Thick**

**Frame Regular**



Frame Thick

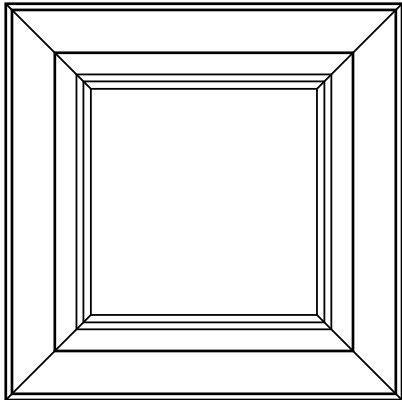

600 / 595 mm

600 / 595 mm

Frame Regular

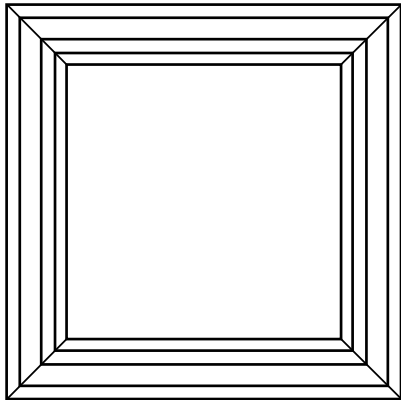

600 / 595 mm

600 / 595 mm

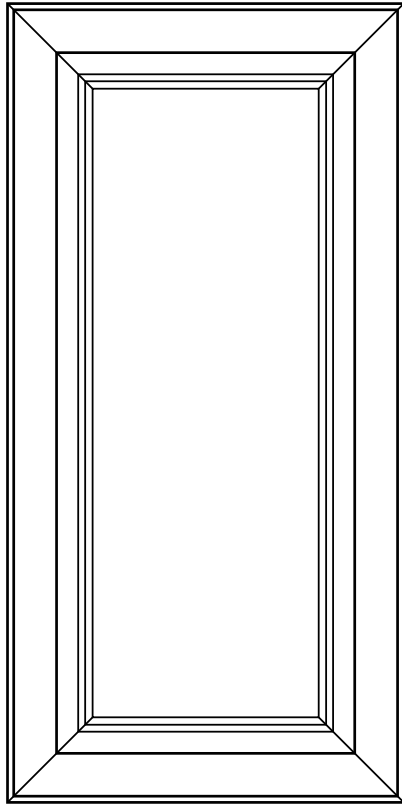

1200 / 1195 mm

600 / 595 mm

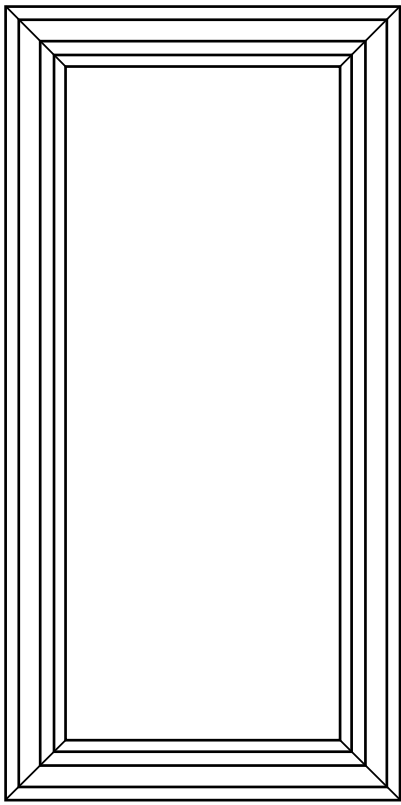

1200 / 1195 mm

600 / 595 mm

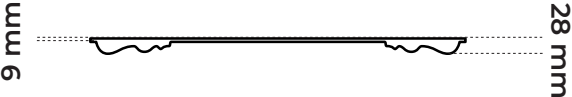



Light Grey  
EP28



White  
EP24



Cream  
EP43



Beighe  
EP07



Mocca  
EP14



Taupe  
EP22



Sea Sand  
EP208



Olive Leaf  
EP207



Grey Stone  
EP206



Autumn Green  
EP45

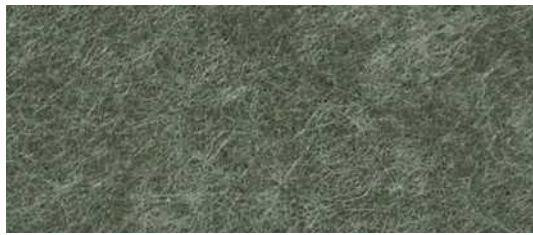

Gray Khaki  
EP93

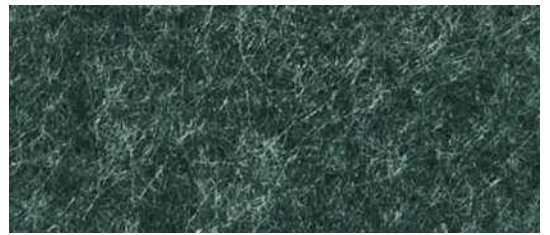

Cypres Tree  
EP803



Silver  
EP03

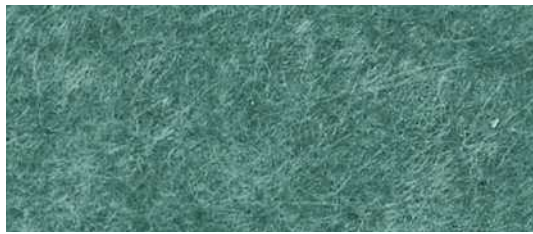

Forest Green  
EP103



Ash  
EP04





Rose Shadow  
EP405

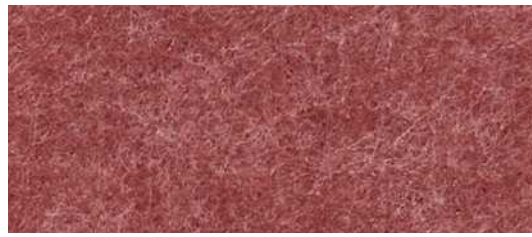

Cherry  
EP123

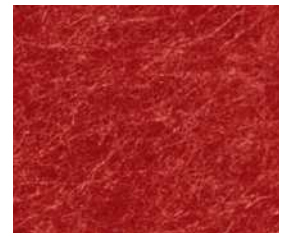

Red  
EP25



Yellow  
EP11



Orange  
EP06

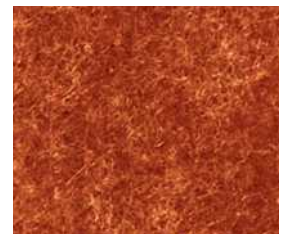

Terra Cotta  
EP125



Bright Horizon  
EP608



Blue Sky  
EP605



Blue Ocean  
EP50



Light Blue  
EP05



Blue Jeans  
EP92



Dark Grey  
EP18



Dark Blue  
EP51



Black Berry  
EP57



Black  
EP09



Strip Wenge  
EPW0202N



American Walnut  
EPW0203N



Teak  
EPW0302N



Strip American Cherry  
EPW0304N



Strip European White Oak  
EPW0401N



Flower European White Oak  
EPW0402N





Split Oak  
EPW0404N



European White Oak  
EPW0405N



Strip White Oak  
EPW0407N



Smoked Oak  
EPW0408N



Strip Maple  
EPW0504N



Strip Greige Oak  
EPW0702N



PREPARATIONS - METHOD 1 - DIRECT FIXED

Make sure that the ceiling construction on which you are installing the tiles is leveled and clean. The distance between the centers of the Channels should be 300 mm.

600×600 mm / 595×595 mm

1200×600 mm / 1195×595 mm

STEP 1

Apply strips of construction adhesive to the back of the Frame tile.

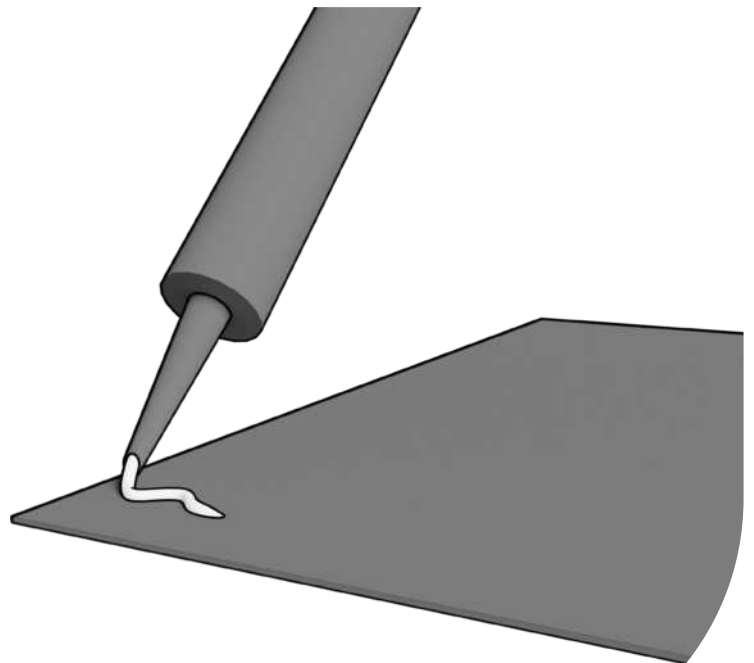

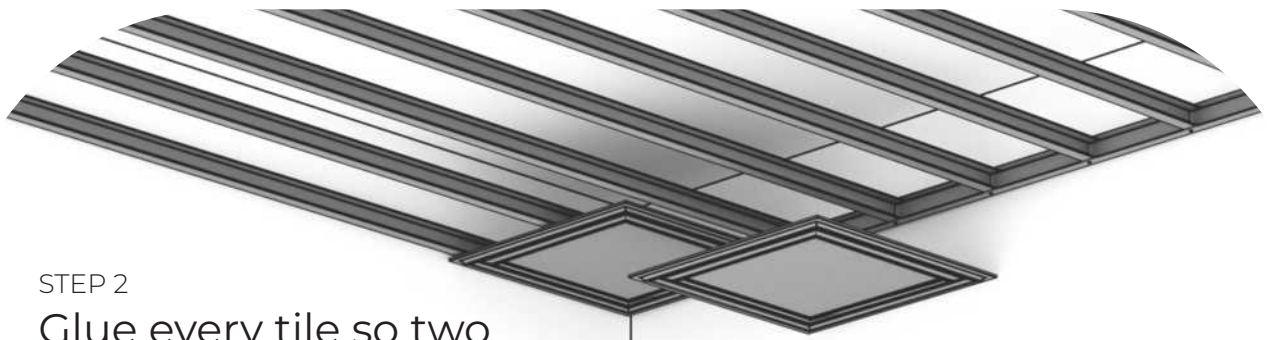
**STEP 2**

Glue every tile so two of its sides are on studs, and another one at the middle.

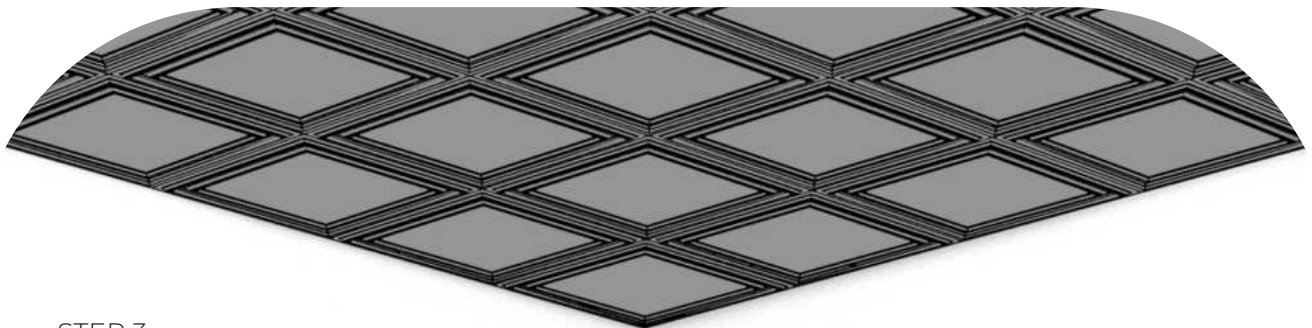
**STEP 3**

Repeat the process for the entire ceiling.



PREPARATIONS - METHOD 2 - SQUARE EDGE

Make sure that the ceiling construction on which you are installing the tiles is leveled and clean.

1195x595 mm / 595x595 mm

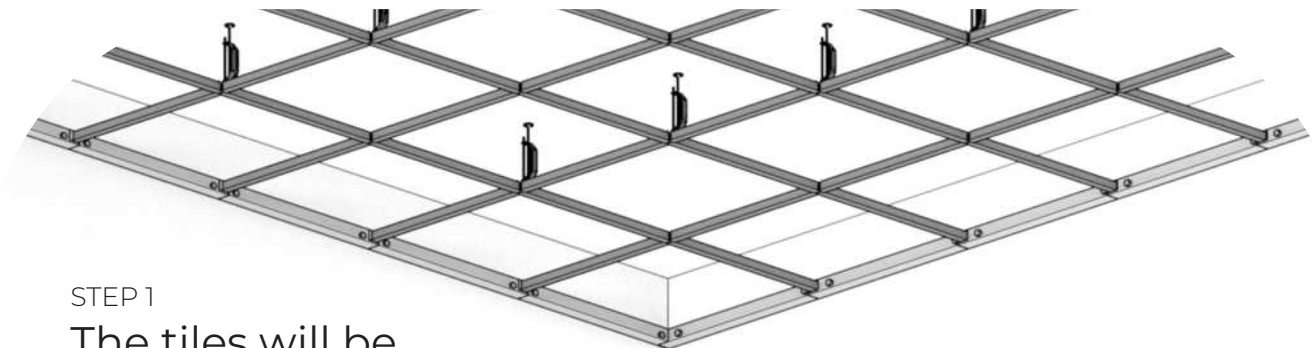

STEP 1

The tiles will be installed on a T24 ceiling grid. The distance between the centers of the main profiles or the cross profiles should be 600 mm.





## STEP 2

Lay the tile in the T24 ceiling grid the following way.

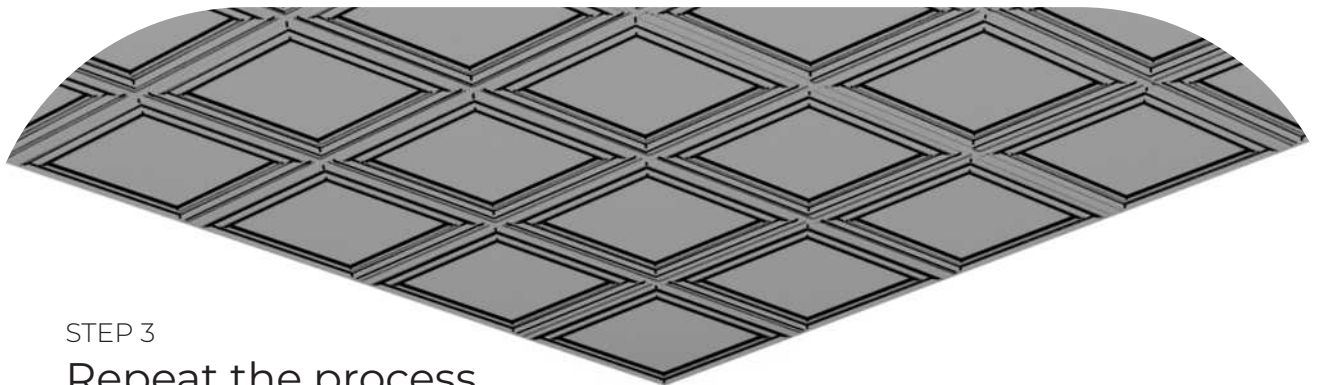
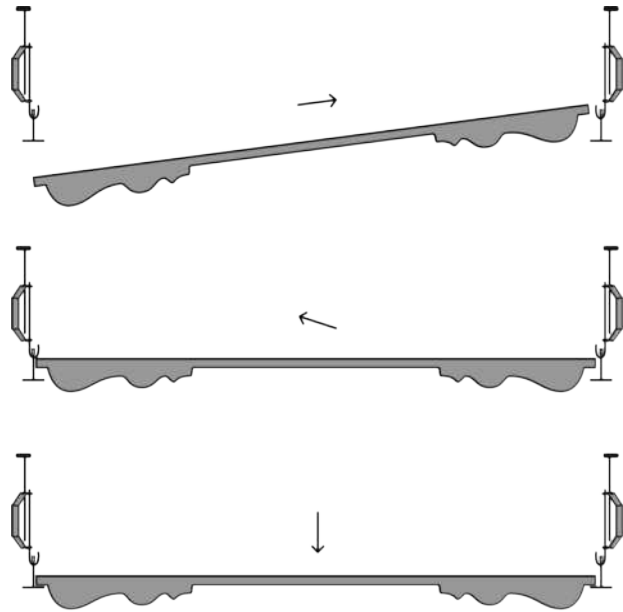

## STEP 3

Repeat the process for the entire ceiling.